

GET STARTED

Assemble Your EZ-Up Chin-up & Inversion Rack

Follow along with these instructions

OR

Scan to download the free BILT app
and search 'Teeter' in app.



BILT.

3D Interactive Instructions

WELCOME TO THE TEETER FAMILY

Congratulations on your purchase of the Teeter EZ-Up™ Chin-Up Inversion Rack! This product has been designed as a multi-functional fitness tool, to be ideally paired with Teeter EZ-Up™ Gravity Boots to ensure the most comfortable and effective inversion experience.

In order to utilize this product to its fullest extent, it is critical that you follow the assembly instructions and read and fully understand the Assembly and User Instructions prior to using your new Teeter EZ-Up Chin-Up Inversion Rack.

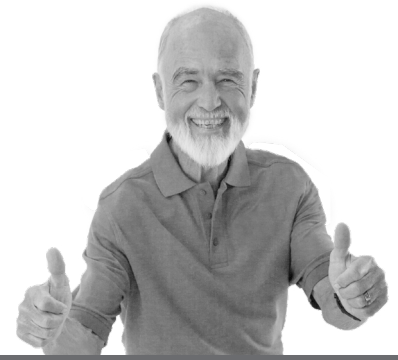

“I created Teeter so people could live healthier and more active lives.”

-Roger Teeter



CONTACT CUSTOMER SERVICE

If you have any questions concerning assembly or if any parts are missing, DO NOT RETURN THE ITEM TO THE STORE OR CONTACT THE RETAILER. Our dedicated product service experts can help! Contact Teeter Customer Service at **800-847-0143**, or via online forms or Live Chat at **teeter.com**.



5-YEAR WARRANTY

Trust Teeter for unmatched quality and performance, backed by our industry-leading warranty coverage. To register your product warranty, go to **teeter.com/Support/Warranty-Registration**.

TABLE OF CONTENTS

Important Safety Instructions	1
Items for Assembly	2
Understanding Your Inversion Rack	3
Safety Warning Labels & Product Specifications	4
Assembly Steps	5 – 11
Warranty Terms & Registration	12
Terms & Conditions	14 – 15

BEFORE YOU BEGIN: Review all steps before beginning assembly and read all precautions before use. Carefully adhere to the Instructions to help ensure safety and product integrity. The below warnings and subsequent instructions assume use of the Inversion Rack with Teeter's EZ-Up Gravity Boots. Be sure to also review the materials that accompany the Gravity Boots.

IMPORTANT SAFETY INSTRUCTIONS

READ ALL INSTRUCTIONS BEFORE USING THE EZ-UP CHIN UP & INVERSION RACK

⚠ WARNING

FAILURE TO FOLLOW INSTRUCTIONS AND WARNINGS COULD RESULT IN SERIOUS INJURY OR DEATH.

To reduce the risk of injury:

- Read and understand all the instructions, review all other accompanying documents, and inspect the equipment before using the Inversion Rack. It is your responsibility to familiarize yourself with the proper use of this equipment and the inherent risks of inversion if these instructions are not followed, such as falling on your head or neck, pinching, entrapment, equipment failure or aggravating a pre-existing medical condition. It is the responsibility of the owner to ensure that all users of the product are fully informed about the proper use of the equipment and all safety precautions.
- **ALWAYS** read and understand the instructions and warnings associated with and accompanying any supplementary equipment, such as Teeter EZ-Up Gravity Boots.
- **DO NOT** use until approved by a licensed physician. Inversion is contraindicated in any medical or health condition that may be made more severe by an elevation of blood pressure, intracranial pressure or mechanical stress of the inverted position, or that may impact your ability to operate the equipment. This may include injury or illness, but also the side effects of any drug or supplement (prescribed or over-the-counter). Specific conditions may include, but not be limited to:
 - Any condition, neurological or otherwise, which results in unexplained tingling, weakness or neuropathy, seizure, sleep disorder, lightheadedness, dizziness, disorientation, or fatigue, or impacts strength, mobility, alertness, or cognitive ability;
 - Any brain condition, such as trauma, history of intracranial bleed, history or risk of TIA or stroke, or severe headaches;
 - Any condition of the heart or circulatory system, such as high blood pressure, hypertension, increased risk of stroke, or use of anticoagulants (including high doses of aspirin);
 - Any bone, skeletal or spinal cord condition or injury, such as significant spinal curvature, acutely swollen joints, osteoporosis, fractures, dislocations, medullary pins or surgically implanted orthopedic supports;
 - Any eye, ear, nasal or balance condition, such as trauma, history of retinal detachment, glaucoma, optic hypertension, chronic sinusitis, middle or inner ear disease, motion sickness, or vertigo;
 - Any digestive or internal condition, such as severe acid reflux, hiatal or other hernia, gallbladder or kidney disease;
 - Any condition for which exercise is specifically directed, limited or prohibited by a physician, such as pregnancy, obesity, or recent surgery.
- **ALWAYS** install Locking Brackets in a SOLID WOOD doorway built according to U.S. national building codes, which measures between 28-36 in (71.1-91.4 cm) wide and has been built according to U.S. national building codes. **DO NOT** use in faux or metal doorways.
- When using with Gravity Boots, **ALWAYS** be certain the Gravity Boots are properly adjusted and that your ankles are secure before using the equipment. Ensure that the Gravity Boots are snug, close fitting and secure EVERY TIME you use the equipment.
- When using the Gravity Boots, **ALWAYS** wear securely tied lace-up shoes, such as normal style tennis shoes. **DO NOT** wear clothing or footwear that can interfere with securing the Gravity Boots, such as high-tops or any shoes that extend above the ankle bones.
- When using the Gravity Boots with EZ-Up Rack or Bar, **ALWAYS** install the EZ-UP Strap to provide assistance with dismount.
- When using the Gravity Boots, **ALWAYS** ensure that the Boots are put on the correct leg so that the buckle levers are on the outside of the leg, versus on the inside where they can rub against each other and unlatch or sustain potential damage.
- When using non-Teeter brand inversion boots, ensure boot hook is compatible with 1.25 in (3.2 cm) diameter bar.
- New users will require the assistance of a spotter possessing the physical strength to lift and return the user to the upright position.
- **DO NOT** continue using the equipment if you feel pain or become light-headed or dizzy. If this occurs while inverting, immediately return to the upright position for recovery and eventual dismount by following the dismounting instructions.
- **DO NOT** use if you are over 250 lbs (113.4 kg) or use by more than one person at a time, otherwise structural failure could occur. **DO NOT** use until the Inversion Rack is tested to exceed your body weight by following the weight test instructions. If the doorframe cracks or any structural failure or weakened condition is observed, **DO NOT** continue use of the Inversion Rack in that doorframe.
- **DO NOT** invert on the Inversion Rack if your height exceeds the distance between the upper bar of the installed Inversion Rack and the floor. **DO NOT** invert from the lower bar. Maximum height allowance depends on the height of the doorway and placement of the locking brackets. In a standard 6'8" (203.2 cm), maximum user height is 7'3" (221 cm).
- **DO NOT** allow children to use the equipment. Keep children, bystanders, and pets away from the equipment while in use. The Inversion Rack is not intended for use by persons with reduced physical, sensory or mental capabilities.
- **DO NOT** store outdoors.
- **DO NOT** use aggressive movements, bounce or swing excessively. While inverted, **DO NOT** use weights, elastic bands, any other exercise or stretching device or non-Teeter attachments. Use the Inversion Rack only for its intended use as described in these instructions.
- **DO NOT** exercise to the point of fatigue while inverted, otherwise returning upright or dismounting may be difficult.
- **DO NOT** use in any commercial, rental or institutional setting. This product is intended for indoor, home-use only.
- **DO NOT** operate equipment while under the influence of drugs, alcohol, or medication that may cause drowsiness or disorientation.
- **ALWAYS** inspect the equipment and the doorframe prior to use. Make sure all fasteners and Locking Brackets are secure.
- **ALWAYS** replace defective components immediately and/or keep the equipment out of use until repair.
- Refer to additional warning notices posted on the equipment. If a product label or User Guide should become lost, damaged or illegible, contact Customer Service at 800-847-0143 for replacement.

SAVE THESE INSTRUCTIONS

ITEMS FOR ASSEMBLY

Items not shown to scale. Hardware drawings located on the insert inside each Hardware Kit.

Carefully remove the individual parts from the carton. You should have all of the items listed below. If any items are missing or damaged, contact your retailer or Teeter Customer Service directly.

ITEM NO. ITEM NAME

Large Bar Assembly

E11040	Large Diameter "L" Bar
E11043	Large Straight Bar w/ Foam Grips
E11052	Large Diameter "Elbow" Bar
E11060	Large Assembly Hardware Kit

Small Bar Assembly

E11047	Small Diameter "L" Bar
E11050	Small Straight Bar w/ Warning Label
E11054	Small Diameter "Elbow" Bar
E11061	Small Assembly Hardware Kit

ITEM NO. ITEM NAME

Mounting Assembly

E11039	Large Locking Bracket (1)
E11008	Small Locking Bracket (1)
E11059	Mounting Assembly Hardware Kit

Attachments

E11015 EZ-Up Strap (included w/ EZ-Up System)

Product Support

LE1019 User Guide (included w/ EZ-Up System)

Not Included

Medium Philips Head Screwdriver, Adjustable Wrench, Drill Motor with 5/32" Drill Bit

Large Bar Assembly

Use with Large Assembly Hardware Kit (E11060)

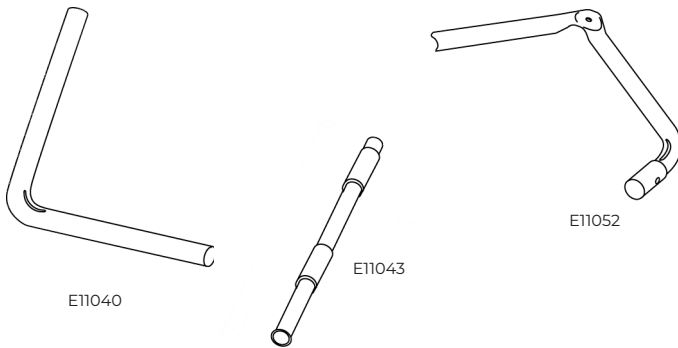

Small Bar Assembly

Use with Small Assembly Hardware Kit (E11061)

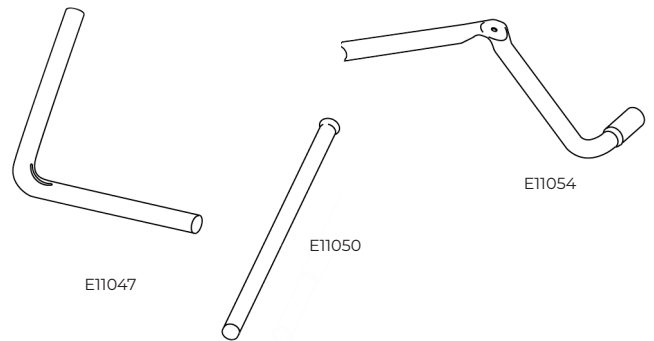

Mounting Assembly

Use with Mounting Assembly Hardware Kit (E11059)



Large Locking Bracket E11039 Small Locking Bracket E11008

Attachments

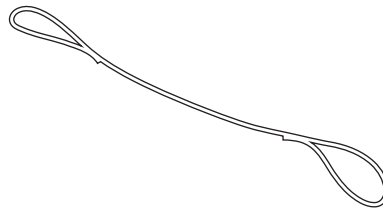

EZ-Up Strap (included w/ EZ-Up System) E11015

Product Support

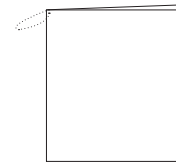

User Guide (included w/ EZ-Up System) LE1019

UNDERSTANDING YOUR EZ-UP RACK

Before reading further, study the drawing below to familiarize yourself with the important assembled components of your EZ-Up Rack.



Parts & Components

- 1 Upper Bar
- 2 Lower Bar with Grips
- 3 EZ-Up Handles
- 4 Door Savers
- 5 Locking Brackets
- 6 EZ-Up Strap (included with EZ-Up System)

SAFETY WARNING LABELS & PRODUCT SPECIFICATIONS

Important: Please review all labels and supporting materials before using your EZ-Up Rack.

This drawing indicates the locations of the warning labels found on your product (image and labels below not shown at actual size). If a label is missing, illegible or is removed, contact Teeter Customer Service to request a complimentary replacement label.

⚠ WARNING

SERIOUS INJURY OR DEATH MAY OCCUR IF PRECAUTION IS NOT TAKEN DURING USE OR IF THE PRODUCT IS IMPROPERLY ASSEMBLED AND INSTALLED. To reduce this risk:

- READ and understand all warnings and instructions in the Assembly Instructions and User Guide before assembling or attempting to use.
- ONLY install Locking Brackets in a SOLID WOOD doorway built according to national building codes. Maximum door width 36 in (91.4cm). Use only the hardware provided. DO NOT use in faux or metal doorways. Inspect doorway and Locking Brackets are secure before each use.
- DO NOT invert until properly weight / height tested as defined in Assembly Instructions. Use a spotter until confident operating.
- DO NOT overexert yourself while inverted, otherwise returning upright may be difficult.
- DO NOT allow children on this product. Keep children, bystanders and pets away when in use.

• Weight Capacity: 250 lb (113.6 kg). For consumer, indoor Home-Use Only.

Replace label if damaged, illegible or removed.



Assembled Dimensions: 39.0 in x 23.0 in x 9.0 in (99.0 cm x 58.0 cm x 22.9 cm)

Weight (approx.): 24.0 lbs (10.9 kg)

LET'S GET STARTED

Unpack and Prepare Your Workspace

Unpack all parts and support materials.
Set aside packing materials and clear your work area.

Locate the Hardware Kits packaged with the manuals.
They are labeled to correspond with the assembly process.

STEP 1

ASSEMBLE LARGE DIAMETER BARS

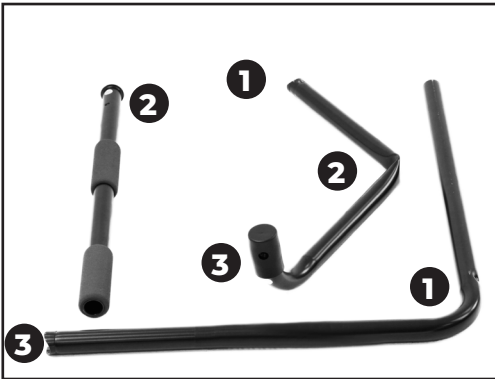

Figure 1

Figure 1: Locate the three Large Bar Assembly pieces labeled joints 1, 2, and 3, and the Large Assembly Hardware Kit (E11060).

Figure 2: Position the Large Diameter “L” Bar and Large Diameter “Elbow” Bar together, aligning joints marked 1 and 3.

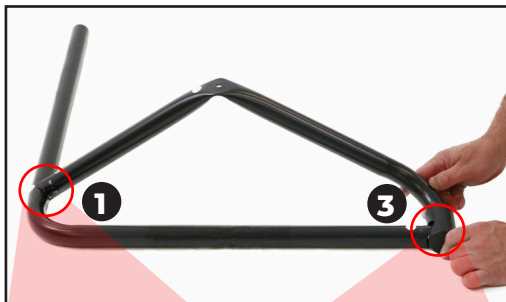

Figure 2

Figure 2A: Assemble Joint 1

Seat the curved flange of the Elbow Bar over the hole in the L Bar. Insert a 2 in (5 cm) bolt through the L Bar into the flange and hand-tighten loosely. Do not fully tighten.

Figure 2B: Assemble Joint 3

Insert the end of the L Bar into the Door Saver opening on the Elbow Bar. Insert a 2 in (5 cm) bolt through the outside of the Door Saver into the L Bar and hand-tighten loosely. Do not fully tighten.



Figure 2A

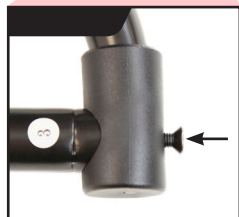

Figure 2B

Align the Straight Bar with Grips under the Elbow Bar at joint 2, with the countersink facing down (Figure 3).

Figure 3A: Assemble Joint 2

Insert the 1 ¾ inch (4.4 cm) bolt up through the Straight Bar countersink and through the “Elbow” Bar. Hand tighten with the nut. Do not fully tighten.

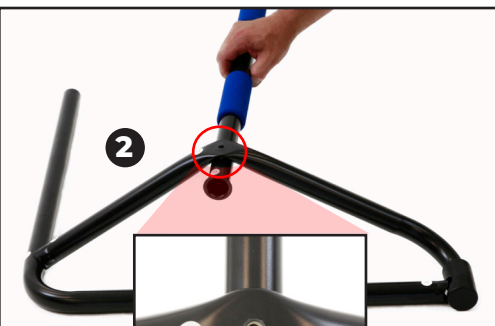

Figure 3

Figure 3A

Countersink

STEP 2

ASSEMBLE SMALL DIAMETER BARS

Figure 4: Locate the three Small Bar Assembly pieces labeled joints 4, 5, and 6, and the Small Assembly Hardware Kit (E11061).

Figure 5: Align the Small Diameter “L” Bar with the Small Diameter “Elbow” Bar, matching joints 5 and 6.

Figure 5A: Assemble Joint 5

Seat the curved flange at the end of the “Elbow” Bar over the hole on the “L” Bar.

Seat the curved flange of the Elbow Bar over the hole in the L Bar. Insert a 2 in (5 cm) bolt through the L Bar into the flange and hand-tighten loosely. Do not fully tighten.

Figure 5B: Assemble Joint 6

Insert the end of the L Bar into the Door Saver opening on the Elbow Bar. Insert a 2 in (5 cm) bolt through the Door Saver into the L Bar and hand-tighten loosely. Do not fully tighten.

Figure 6: Align the Small Straight Bar under the Elbow Bar at joint 4, with the countersink facing down.

Figure 6A: Assemble Joint 4

Insert the 1½ in (3.8 cm) bolt up through the Straight Bar countersink and Elbow Bar. Hand-tighten with the nut. Do not fully tighten.

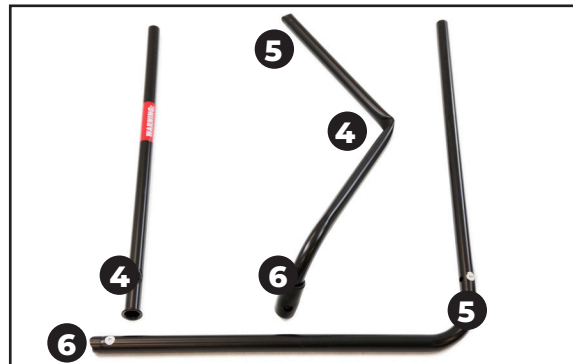

Figure 4

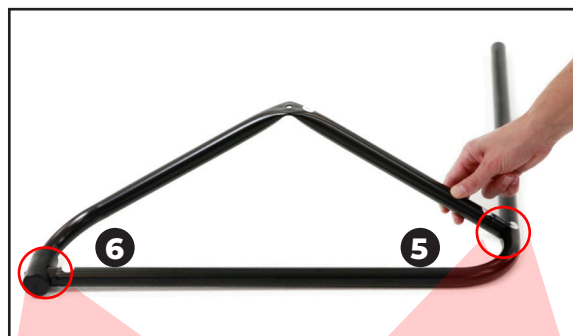

Figure 5

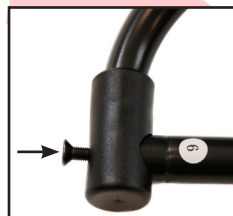

Figure 5A



Figure 5B

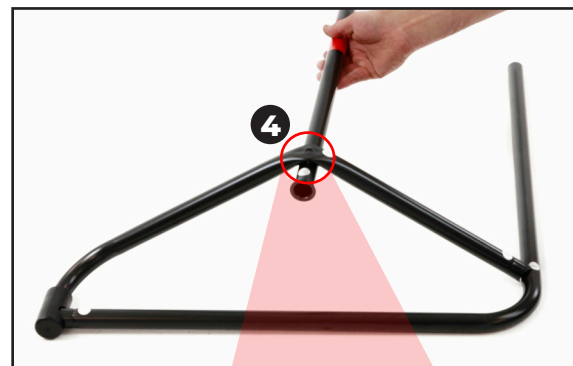

Figure 6



Figure 6A

Countersink

STEP 3

ATTACH LARGE & SMALL ASSEMBLIES

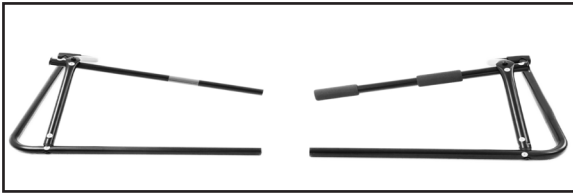

Figure 7

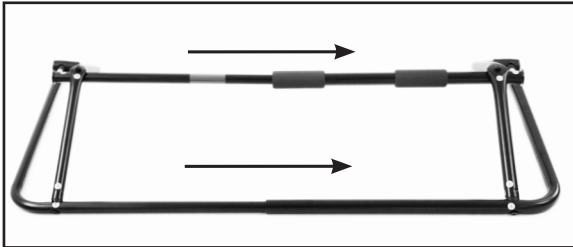

Figure 8

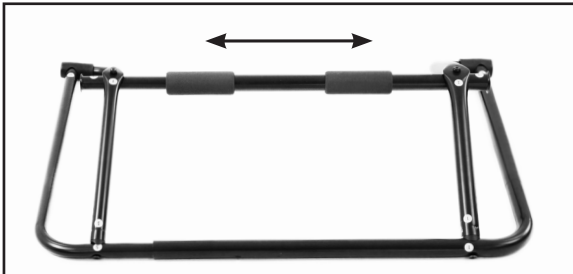

Figure 9

Figures 7 - 8: Align and slide the Small Bar Assembly (labeled 4, 5, 6) into the Large Bar Assembly (labeled 1, 2, 3).

Figure 9: The Rack width is adjustable by sliding assemblies in or out to fit doorways 28–36 in (71–91.4 cm). For assembly, slide together to the narrowest width.

SECURELY TIGHTEN ALL BOLTS and NUTS (3 per side) using a screwdriver and wrench.

STEP 4 INSTALL LOCKING BRACKETS

⚠ WARNING

Serious injury or death may occur if the Inversion Rack is not installed in the doorframe properly: **ALWAYS** securely install the Locking Brackets in **SOLID WOOD** doorways built according to U.S. national building codes (maximum width of 36 in/91.4 cm). Maximum height allowance depends on the height of the doorway and placement of the locking brackets. In a standard 6'8" (203.2 cm), maximum user height is 7'3" (221 cm).

Locate the Mounting Hardware Kit (E11059).

Figure 10: To prevent interference with door operation, mount the Locking Brackets on the side of the doorframe opposite the hinged door.

There are two sizes of Locking Brackets, one to fit the Large Straight Bar with Grips and one to fit the Small Straight Bar. Facing the door, mount the Large Locking Bracket (A) on your RIGHT and the Small Locking Bracket (B) on your LEFT.

Figure 11: Using a pencil, mark 2 in (5 cm) down from the top of the doorframe on both sides. On the RIGHT side of the doorframe, place the Large Locking Bracket with the plastic rotating lock fully open against the doorstop edge. Align the top of the Locking Bracket with the pencil mark so there is a 2 in (5 cm) clearance between the Locking Bracket and top of the doorframe.

NOTE: If you find use of the Inversion Rack difficult at this height, you may lower the Rack as long as the top bar height exceeds the height of the tallest user in the household.

With a pencil, mark the doorframe through the three (3) screw holes in the bracket. Set the bracket aside and pre-drill 5/32 inch (3.9 mm) diameter holes where you marked the doorframe, at least 2 inches (5 cm) deep.

Mount the bracket using the three (3) wood screws provided - **DO NOT** substitute with any other screws. Ensure all screws fully engage the door frame and are tight and flush with the bracket.

Following the same procedure as above, install the Small Locking Bracket on the LEFT side, with the same distance from the top of the doorframe as the Large Locking Bracket.

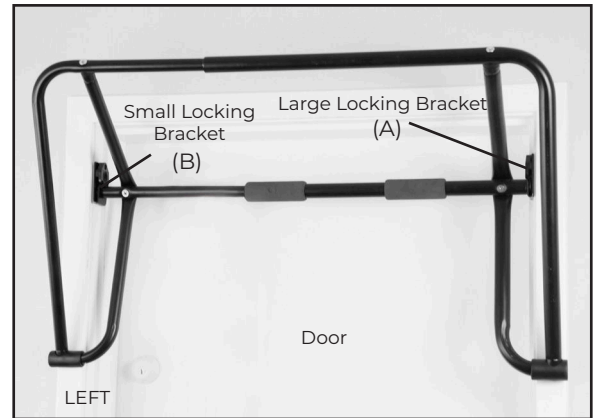

Figure 10



Figure 11

STEP 5

INSTALL EZ-UP RACK INTO DOORFRAME



Figure 12

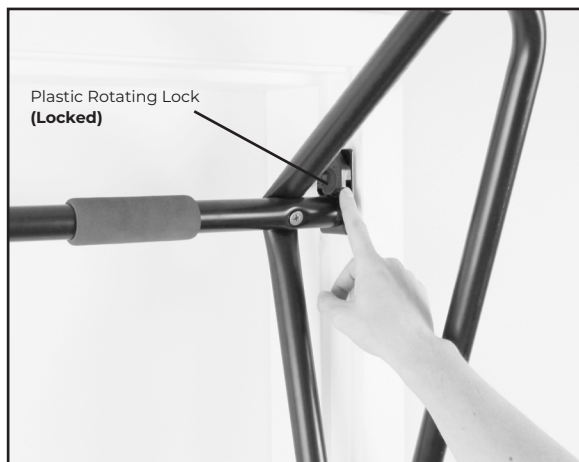

Figure 13

Figure 12: With the Upper Bar facing you, hold the EZ-Up Rack near the ends of the Lower Bar. Slide the flared end of the Large Straight Bar into the U-Shaped Rest in the RIGHT locking bracket, making sure the bar seats fully over the pin at the base of the bracket and rests at the bottom.

Extend the length of the EZ-Up Rack until the flared end of the Small Straight Bar can slide into the U-Shaped Rest in the LEFT locking bracket, **NOT** to exceed 36 in (91.4 cm) wide.

Figure 13: Lock the EZ-Up Rack into the Locking Brackets by snapping the plastic rotating locks over the top of the Lower Bar.

⚠ WARNING

Failure of the rotating lock to snap over the Lower Bar is indication of improper assembly and if not corrected, could result in serious injury or death! Always ensure the Locking Brackets are locked securely over the Lower Bar before use.

If the EZ-Up Rack obstructs normal passage through the doorway, remove it after each use by rotating the plastic locks off the Lower Bar, then lifting the Rack out of the U-Shaped Rest.

STEP 6

ATTACHING & STORING THE EZ-UP STRAP

Figure 14A & B: Once the Rack is fully assembled and mounted to the doorframe, loop the EZ-Up Strap over the Lower Bar.

Feed the large-looped end of the strap through the small-looped end and pull until the fit is snug around the lower bar.

Figure 15: To store the EZ-Up Strap when not in use, wrap the strap around the Small Diameter Bars and tuck the end to secure.



Figure 14A



Figure 14B

⚠️ WARNING

To prevent entanglement, always ensure the EZ-Up Strap is properly stored while not in use.



Figure 15

STEP 7 TEST WEIGHT & HEIGHT

⚠ WARNING

FAILURE to test and inspect the equipment prior to first use could result in serious injury or death!

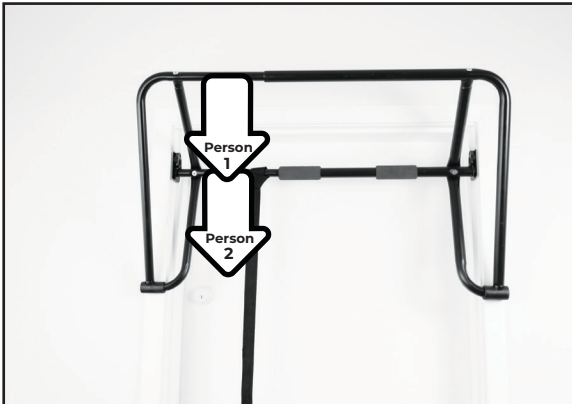

Figure 16A

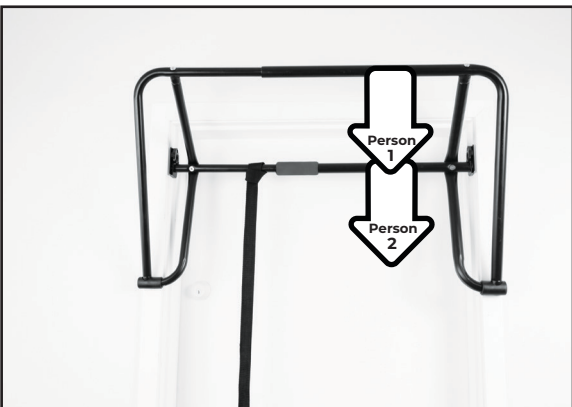

Figure 16B

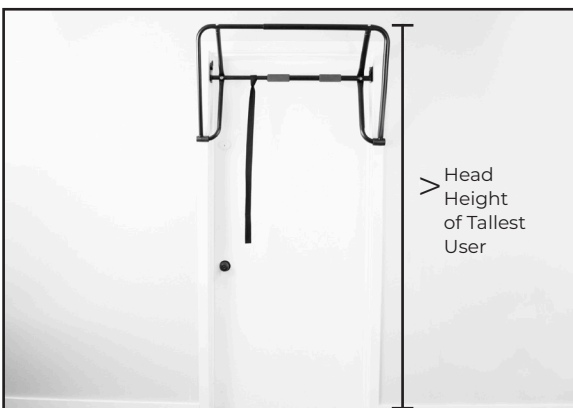

Figure 17

Weight Test

Figure 16A & B: After installing the Locking Brackets and securing the EZ-Up Rack in place, the user and another adult person with a combined weight equal to or greater than 1.5 times the user's weight should hang by their hands from one side (one person on the Upper Bar and one on the Lower Bar) and bounce several times applying their full weight

Repeat the test on the other side.

If the doorframe shows cracks or any signs of instability or weakness, **DO NOT** continue use of the EZ-Up Rack in that doorframe.

Height Test

Figure 17: Measure between the Upper Bar and floor to ensure the distance is greater than the head height of the tallest user in the household.

The Teeter warranty set forth below and on Teeter's website applies to US and Canadian customers only. For international customers, please consult your local distributor for warranty information which will vary depending on country.



5-YEAR
WARRANTY

During the period starting with the day of retail purchase and continuing for five (5) years, Teeter extends to the owner a repair and replacement warranty against manufacturing defects in materials, workmanship, fabrics and padding. Teeter will repair or replace any such defect and will pay the costs of all parts, labor and transportation. If a repair or replacement is not commercially practical or cannot timely be made, then Teeter will, at the original Purchaser's option, replace with a comparable product or refund the purchase price.

Handling and transportation costs related to product warranty service only are covered by this warranty. This warranty does not cover damage resulting from improper handling, assembly, or installation, repairs made by others, accident, misuse, or abuse. Under no circumstances shall Teeter, or any other party involved in the sale of this product, have any liability for incidental or consequential damage arising from breach of an express or implied warranty on any Teeter product.

EXCEPT AS SET FORTH ABOVE, NO WARRANTY IS GIVEN WITH RESPECT TO ANY TEETER PRODUCT, AND ALL EXPRESS WARRANTIES ARE DISCLAIMED. This warranty shall be governed by the laws of the State of Washington, USA. To the extent this warranty is found not to be enforceable, it shall be deemed revised to the extent necessary to make it enforceable. This warranty and any controversy or claim arising out of this warranty or its interpretation shall be governed by the laws of the State of Washington, USA. Any controversy or claim arising out of or relating to this warranty, its interpretation, or any alleged breach thereof, which cannot be amicably settled between Teeter and the owner within sixty (60) days of written notice by the aggrieved party to the other, shall be finally settled by arbitration submitted to three (3) arbitrators selected from the panels of the arbitrators of the American Arbitration Association located closest to Teeter's principal place of business.

Some states do not allow the exclusion of incidental or consequential damage from a warranty, so the above limitation or exclusion may not apply to you. Some states do not allow limitations on how long an implied warranty lasts, so the above limitation may not apply to you. This warranty gives you specific legal rights, and you may also have other rights which may vary from state to state.

HOW TO SUBMIT YOUR REGISTRATION:

Step 1

Fill out this information for your own records.

Date of Purchase

Product & Model

Step 2

Go online to teeter.com to register your warranty.

Dealer Name

If you are unable to go online, you can request a warranty card to be mailed to you by calling Customer Service at 800-847-0143. Please DO NOT mail this to Teeter.



PLEASE RETAIN THIS FOR YOUR RECORDS

This page intentionally left blank.

TERMS & CONDITIONS OF PURCHASE

YOUR PURCHASE IMPLIES AGREEMENT TO THE FOLLOWING TERMS, which were made available to you prior to purchase via Teeter-owned web properties (including but not limited to teeter.com and forwarding URL's like tryteeter.com and tryfreestep.com) ("Sites") or by contacting Teeter Customer Service. Your purchase signifies your agreement to all terms, conditions, and notices contained or referenced herein. If you do not agree to these Terms of Use ("Terms"), you may return the product (unopened and unused), for a refund in accordance with the Teeter Return Policy within 90 days of your first order of any Teeter products. THESE TERMS CONTAIN AN ARBITRATION AGREEMENT AND CLASS ACTION WAIVER. READ THEM CAREFULLY, BECAUSE THEY AFFECT YOUR LEGAL RIGHTS.

The terms and conditions marked with a * only apply to purchases made direct from Teeter (via phone or Sites). If your purchase was made through a Teeter Authorized Dealer, the * terms and conditions are dictated by that dealer.

CONTACT INFORMATION: Teeter is authorized to use any phone number you provide to contact you for account maintenance and billing purposes.

OUR GUARANTEE*: All of our products carry a specific money-back guarantee starting from the date that the product is delivered to you. Please review the information provided with your product for specific details. For information regarding product returns, please review our Return Policy below.

Teeter also offers a 30-Day Price Match Guarantee. If at any time within 30 days of placing your order, you find the same, new-condition model advertised in print or online by a Teeter authorized dealer for a lower price, send Teeter customer service a copy of the ad (dated and published within 30 days of placing your order) and they will either adjust your future payments for the new price or refund you the difference.

SHIPPING*: Unless otherwise noted, Teeter will use commercially-practical efforts to ship products within a reasonable time after receipt of your properly completed order. Although Teeter may provide delivery or shipment timeframes or dates, you understand that those are good-faith estimates and may be subject to change. You further understand that product availability may be limited and particular products may not be available for immediate delivery, in which case the products will be delivered when available. Teeter shall not be liable for any loss, damage, cost, or expense related to any delay in shipment or delivery.

AUTOMATIC RENEWAL / AUTO-SHIP PROGRAMS*: With regards to any product made available to you on an auto-renew or monthly (or other period) subscription as sold through the Site or otherwise (including any free trial product) (the "Product"), the default term of our agreement shall be for so long as we make the Product available to you. IF YOU HAVE PROVIDED US WITH A VALID CREDIT CARD NUMBER OR AN ALTERNATE PAYMENT METHOD, YOUR SUBSCRIPTION WILL BE AUTOMATICALLY RENEWED (AND CHARGED TO THE ACCOUNT YOU HAVE PROVIDED) FOR ANOTHER TERM AT THE EXPIRATION OF YOUR CURRENT TERM, WHENEVER LOCAL REGULATIONS ALLOW, FOR A FEE NO GREATER THAN OUR THEN-CURRENT PRICE, EXCLUDING PROMOTIONAL AND DISCOUNT PRICING.

The new term will be for the same duration as the expired term unless otherwise specified at time of renewal. This renewal will be processed (and your card charged) within 30 days prior to the expiration of the term and each period thereafter. IF YOU DO NOT DESIRE TO HAVE YOUR SUBSCRIPTION AUTOMATICALLY RENEWED, YOU MUST, PRIOR TO THE EXPIRATION OF YOUR SUBSCRIPTION TERM, INFORM US OF YOUR INTENTION NOT TO RENEW YOUR SUBSCRIPTION TO THE PRODUCT BY CALLING OUR CUSTOMER SERVICE.

You must provide current, complete, and accurate information for your billing account. You are responsible for ensuring this information is correct and must promptly update all information to keep your billing account current, complete, and accurate (such as a change in billing address, credit card number, or credit card expiration date). You must promptly notify us if your credit card is canceled (for example, for loss or theft). Changes to such information can be made by contacting Customer Service.

We reserve the right to refuse or discontinue the supply of the Product to any user at any time at our sole discretion.

RETURNS*: If you wish to return your purchase, contact Teeter Customer Service and request a Return Authorization within 90 days (or within 30 days to avoid your first payment if financed), then follow the proceeding return instructions. When an item is returned, the refund and how the refund is issued may differ based on the condition of the item, the timeframe, and how the item was purchased. Teeter offers a 90-day return window (from the date item is received) to return the product for a full refund (less return shipping and interest). Returns are allowed past the return window up to 120 days after receipt for partial credit of the original purchase price (see below). The customer is responsible for the cost of shipping the product back to Teeter unless the product is defective, in which case Teeter must be given the opportunity to offer warranty service or replace the product.

If You Return:

- Item(s) in original condition within the return window (90-days from receipt after delivery)
- Item(s) in original condition past the return window (91-120 days. No returns are accepted past 120 days)
- Items that are returned damaged, missing parts, not in the original condition, or have obvious signs of use (reasons not due to a Teeter error)

You'll Receive:

- 100% of the item's price[^] (less shipping & handling, financing interest paid is non-refundable)
- 80% of the item's price[^] (financing will be refunded and separately charged a restocking fee equal to 20% of the purchase price)
- Up to 50% of the item's price (financing will be refunded and separately charged a restocking fee equal to 50% of the purchase price)

[^] Refunds are for product only and do not include any processing, interest, shipping or handling fees. Freight on refused deliveries will be deducted from the credit or charged to account number on file.

Returns must have a valid Return Merchandise Authorization (RMA) number issued by Teeter. If merchandise delivery is refused without inspection, the refund will be for the purchase price, less all shipping charges (original and return) and trial fees. The product must be returned in original condition undamaged with all parts and support materials in its original carton. Refunds are for product only and do not include any processing fees, trial fees, shipping or handling fees. Freight on refused deliveries will be deducted from the credit. All return shipping charges must be prepaid; C.O.D. deliveries are not accepted. It is recommended that you acquire shipment tracking and insurance for the entire value of your product. We do not assume responsibility for merchandise damaged or lost during transit. Refunds are issued after a product is received and inspected; processing can take up to ten (10) days. For products on a multi-payment plan, payments will continue to charge to the credit card on file until the product is received and processed at our warehouse. Refunds, including gift returns, are made in the same form as the original payment for purchase. Please allow up to eight (8) weeks for your bank or credit card company to post this refund on your statement. Merchandise returned without a valid RMA number or in violation of this policy will not qualify for a refund. Teeter will discard the product and the customer will be responsible for any remaining payment due.

All shipments leave the Teeter warehouse in good condition. Any damage, shortages, or product lost in transit should be reported to Teeter within fourteen (14) days.

PRODUCT DESCRIPTIONS AND PRICING*: For questions about Teeter products or services, or for questions about orders placed through the Sites or otherwise, please contact Teeter Customer Service at 800-847-0143 or email at info@teeter.com.

Teeter and its affiliates attempt to be as accurate as possible. However, Teeter does not warrant that product descriptions or other content is accurate, complete, reliable, current, or error-free. If a product offered by Teeter itself is not as described, your sole remedy is to return it in unused condition.

In ordering products, you agree to provide only true, accurate, current, and complete information. You hereby certify that any e-mail account you provide to Teeter is registered to you. Teeter reserves the right to bar your access to and use of the Sites or further business transactions if it has reasonable grounds to believe that you have provided untrue, inaccurate, not current, or incomplete information to Teeter. You agree that if you are ordering or purchasing products on behalf of a company, that you have sufficient authority to bind that company to the Terms. You agree that your placement of an order is sufficient to satisfy the Statute of Frauds, and no further writing is required.

All prices are quoted in U.S. dollars. Teeter may prohibit delivery to addresses outside the United States and Canada. Teeter will add shipping and handling fees and applicable sales/use tax. Products are available while supplies last. Descriptions of, or references to, products not owned by Teeter do not imply endorsement of that product, or constitute a warranty, by Teeter.

TAXES: For current sales tax collection information, go to teeter.com/support/tax-disclaimer.

DISPUTE RESOLUTION BY INDIVIDUAL BINDING ARBITRATION: You and Teeter agree that any dispute between us (including disputes against any agent, employee, subsidiary, affiliate, predecessor in interest, successor, or assign of the other) relating to the Sites; any transaction or relationship between us resulting from your use of the Sites; the purchase, order, installation, or use of Teeter products or services; or communications between us; will be resolved exclusively and finally by binding arbitration and the arbitration decision may be enforced and judgment entered thereon in any court of competent jurisdiction. You and Teeter further agree that this arbitration agreement is made pursuant to a transaction involving interstate commerce and shall be governed by the Federal Arbitration Act (“FAA”), and not by any state law concerning arbitration. You and Teeter further agree that any determination regarding the applicability, enforceability, or validity of this arbitration agreement will be made by the arbitrator, not by any court. **BY AGREEING TO THIS ARBITRATION AGREEMENT, YOU ARE GIVING UP YOUR RIGHT TO GO TO COURT, INCLUDING YOUR RIGHT TO A JURY TRIAL.** In arbitration, a dispute is resolved by a neutral arbitrator or panel of arbitrators, rather than by a judge or jury. Arbitration is more informal; however, an arbitrator can award the same relief that a court can award. The arbitration will be administered by the American Arbitration Association (“AAA”), and conducted under AAA’s Commercial Arbitration Rules and the Supplementary Procedures for Consumer Related Disputes (collectively, the “AAA Rules”) then in effect at the time of the dispute. You may obtain copies of the AAA Rules and forms and instructions for initiating arbitration by visiting the AAA website at www.adr.org, or by calling AAA at 800-788-7879. If you initiate arbitration, Teeter will promptly reimburse you for any standard filing fee which may have been required under AAA’s Procedures once you have notified Teeter in writing and provided a copy of the arbitration proceedings. However, if Teeter is the prevailing party in the arbitration, applicable law may allow the arbitrator to award attorneys’ fees and costs to Teeter. If for any reason the AAA is unavailable, the parties shall mutually select another arbitration forum. There shall be no right or authority for any claim to be arbitrated on a class action basis or in a purported representative capacity. No claim submitted to arbitration is heard by a jury or may be brought as a private attorney general. You do not have the right to act as a class representative or participate as a member of a class of claimants with respect to any claim submitted to arbitration. The arbitrator may not consolidate more than one person’s claims against Teeter and may not preside over any kind of representative or class proceeding against Teeter. You acknowledge that this class action waiver is material and essential to the arbitration of any disputes between the parties and is nonseverable from the agreement to arbitrate claims. If any portion of this class action waiver is limited, voided, or cannot be enforced, then the parties’ agreement to arbitrate shall be null and void. **YOU UNDERSTAND THAT BY AGREEING TO THIS CLASS ACTION WAIVER, YOU MAY ONLY BRING CLAIMS AGAINST US IN AN INDIVIDUAL CAPACITY AND NOT AS A PLAINTIFF OR CLASS MEMBER IN ANY PURPORTED CLASS ACTION OR REPRESENTATIVE PROCEEDING. IF YOU DO NOT AGREE TO THIS ARBITRATION AGREEMENT AND CLASS ACTION WAIVER, YOU MUST TELL US IN WRITING, NOT USE THE SITES OR TEETER PRODUCTS, AND RETURN THE PRODUCT (UNOPENED AND UNUSED) FOR A REFUND IN ACCORDANCE WITH THE TEETER RETURN POLICY WITHIN 30 DAYS OF YOUR FIRST ORDER OF ANY TEETER PRODUCTS.**

INDEMNIFICATION: NOT ALL HEALTH AND FITNESS PROGRAMS/PRODUCTS ARE SUITABLE FOR EVERYONE AND THIS OR ANY PRODUCT MAY RESULT IN INJURY. CONSULT YOUR DOCTOR BEFORE UTILIZING THIS OR ANY HEALTH OR FITNESS-RELATED PROGRAM/PRODUCT.

To reduce the risk of injury, read and understand the User Guide and/or all accompanying product support before use. If you experience pain or discomfort during use, stop immediately and consult your doctor.

You hereby fully release and agree to indemnify and hold harmless Teeter, its parents, subsidiaries, affiliates, successors, assigns, and their respective officers, directors, members, shareholders, employees, agents, and suppliers from any claim, action, demand, loss, or damages (including attorneys’ fees) arising out of or relating to your use of the Sites, the products, exercises, instructions, or advice on the Sites, or your violation of these Terms or the rights of any third party in connection with the foregoing.

Although Teeter strives to prevent the introduction of viruses and other malware to this Site, Teeter does not warrant, guarantee, or make any representation that the Sites are free of destructive materials. Further, Teeter does not warrant or guarantee that access to this site will be uninterrupted, timely, secure, or error-free, or that defects, if any, will be corrected.

DISCLAIMER OF WARRANTY AND LIMITATION OF LIABILITY FOR USE OF WEBSITE, IF APPLICABLE: The information, products and services on the Teeter Sites are provided on an “AS IS,” and “AS AVAILABLE” basis. Teeter does not warrant the information or services provided herein or your use of the Sites generally, either expressly or impliedly, for any particular purpose and expressly disclaims any implied warranties, including but not limited to, warranties of title, non-infringement, merchantability or fitness for a particular purpose. Teeter will not be responsible for any loss or damage that could result from interception by third parties of any information or services made available to you via the Sites. Although the information provided to you on the Sites is obtained or compiled from sources we believe to be reliable, Teeter cannot and does not guarantee the accuracy, validity, timeliness or completeness of any information or data made available to you for any particular purpose. Neither Teeter nor any of its parents, subsidiaries, affiliates, successors, assigns, and their respective officers, directors, members, shareholders, employees, agents, suppliers, nor any third party vendor, will be liable or have any responsibility of any kind for any loss or damage that you incur in the event of any failure or interruption of the Sites, or resulting from the act or omission of any other party involved in making the Sites, the data contained herein or the products or services offered on the Sites available to you, or from any other cause relating to your access to, inability to access, or use of the Sites or these materials, whether or not the circumstances giving rise to such cause may have been within the control of Teeter or of any vendor providing software or services. In no event will Teeter or any such parties be liable to you, whether in contract or tort, for any direct, special, indirect, punitive, consequential or incidental damages, attorney fees, or any other damages of any kind even if Teeter or any other such party has been advised of the possibility thereof. This limitation on liability includes, but is not limited to, the transmission of any viruses which may infect a user’s equipment, failure of mechanical or electronic equipment or communication lines, telephone or other interconnect problems (e.g., you cannot access your internet service provider), unauthorized access, theft, operator errors, strikes or other labor problems or any force majeure. Teeter cannot and does not guarantee continuous, uninterrupted or secure access to the Web site.

COPYRIGHT: All content included on Teeter Sites, product, and product support, including design, product descriptions, and multimedia content, is the property of Teeter or its content suppliers and protected by United States and international copyright laws.

TRADEMARKS: Teeter, Teeter Move, FitSpine, FitForm, Power 10, DEX, Flex Technology, EZ-Up, ProFlex, “Feel Better, Move Better, Live Better”, “Better Back, Better Body” and other Teeter trademarks and service marks referenced on Sites or in commerce are registered by Teeter. The names of other companies and marks used on third-party products or services mentioned herein may be registered trademarks and service marks or trademarks and service marks of their respective companies and/or owners.

You are prohibited from using our trademarks (and any third-party trademarks) for any purpose including, but not limited to use as meta tags on other pages or sites on the World Wide Web without the written permission of Teeter or such third party, which may own the marks.

PRIVACY POLICY*: Users of Teeter Sites should refer to the Teeter online Privacy Policy for information about how Teeter uses and collects information. You agree that Teeter may disclose your personal information to a third party if Teeter believes in good faith that the law or legal process requires it, to protect the rights or property of Teeter or others, or as otherwise described in the Teeter Privacy Policy at teeter.com.

JURISDICTION: These Terms, as well as the Privacy Policy for the Sites, and any dispute that may arise between you and Teeter, shall be governed by and construed in accordance with the laws of the State of Washington, U.S.A., without regard to conflict of laws principles.

Unless otherwise specified herein, these Terms and the Site’s Privacy Policy constitute written agreements between you and Teeter and supersedes all prior or contemporaneous communications and proposals (whether oral, written, or electronic) between you and Teeter. A printed version, and of any electronic notices pertaining to the same, shall be admissible in a judicial or administrative proceeding to the same extent, and subject to the same restrictions, as any other contract, document or record originally in printed form.

If any provision of these Terms shall be deemed unlawful, void, or for any reason unenforceable, then that provision shall be deemed severable from these Terms and shall not affect the validity and enforceability of any remaining provisions.

The terms of this section survive any termination of the Terms.

This page intentionally left blank.

This page intentionally left blank.

Find these great products and more at teeter.com!

DEX II® Training System

Decompress your back, perform effective core exercises, and strengthen your upper body with the commercial-grade DEX II, rated to 350 lb.



LX9™ Inversion Table

The premier Teeter Inversion Table featuring the FlexTech™ 8-Pt Floating Suspension Bed that flexes as you move, Deluxe EZ-Reach™ Handle to reduce the need for bending, and so much more!



Power10® Elliptical Rower

Torch more calories and enhance muscle definition with one revolutionary rower. The patented elliptical path offers bi-directional resistance so you can engage more muscles with every workout.



FitForm™ Strength Trainer

Total body strengthening in one small package! Work your arms, legs and core with micro-adjusting resistance up to 65 lb.



If you have any trouble assembling the equipment, or questions about its use, please contact customer service at

800-847-0143

info@teeter.com