

**Inverting**

When correctly balanced, the table will rotate in response to simple arm movements. To invert, lift your arms overhead slowly and to return upright, bring your arms back to your sides. Your arms provide the weight needed to rotate the table. (Figure 12).

To ensure the inversion table does not rotate too far, too quickly:

- Set the Rotation Adjustment to Setting “C” (as explained on pg. 2);
- Attach the Tether Strap to the underside of the table and test to maximum rotation;
- Raise one arm at a time, and do so very slowly (the faster you move, the faster the inversion table will rotate).

**Returning Upright**

To return to the upright position, put your arms at your sides. Since your body may have lengthened or shifted on the Table Bed during inversion, you may need to bend your knees to shift your body weight to the foot side of the pivot point. **DO NOT** lift your head or try to sit up (Figure 13).

**Full Inversion**

**Definition:** Hanging completely upside down by your ankles with your back free from the table. **DO NOT** attempt this step until you are comfortable with partial inversion.

**⚠ WARNING**

To reduce tipping hazard, confine all inverted activities to smooth movements. Aggressive exercises that involve vigorous body movement can cause the table to tip over, resulting in serious injury or death!

- Disconnect the Tether Strap.
- Set the Rotation Adjustment in the top hole setting “A” if you want the table to “lock” firmly while inverted. If you are 220 lbs (100 kg) or more, set the Rotation Adjustment in the “B” hole setting.
- From a balanced position on the table, slowly raise both hands over your head to begin rotation. You may need to assist the last few degrees of rotation by pushing on the floor or A-frame until the table pulls away from your back (Figure 14). In your correct balance setting, your weight will keep the table “locked” in this position until you are ready to return upright.

To Release from the Inverted “Locked” Position:

- Place one hand on the top of the Table Bed behind your head and place the other hand on the bottom bar of the A-frame in front of you.
- Pull both hands together (Figure 15). This will rotate the table out of the “locked” position. Slowly move your arms and elbows to your sides to complete the rotation.

**USE CAUTION:** Elbows protruding over the sides of the table bed could get pinched between the A-frame and the Table Bed as you return upright (Figure 16).

**⚠ WARNING**

It is your responsibility to familiarize yourself with the proper use of the equipment and the inherent risks of inversion, such as falling on your head or neck, pinching, entrapment or equipment failure.

**DO NOT** use the inversion table until you have thoroughly and carefully read the Owner’s Manual, viewed the instructional DVD, reviewed all accompanying documents and inspected the equipment. **ALWAYS** test and inspect the equipment for smooth operation prior to each use.

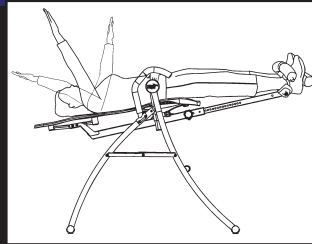

Fig. 12

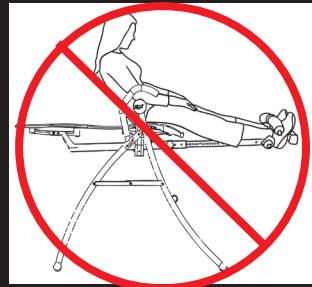

Fig. 13

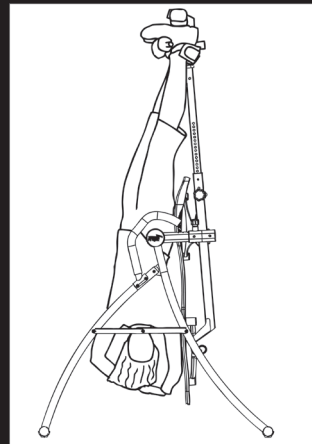

Fig. 14

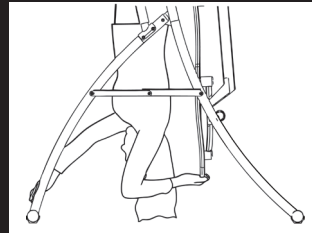

Fig. 15

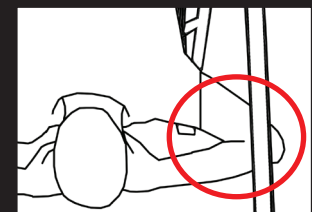

Fig. 16

Meets Medical-Grade Specifications  
UL Listed 53NJ



**OWNER'S MANUAL**

**NXT-R™ Inversion Table**

U.S. and foreign patents apply. Other foreign patents pending.

**⚠ WARNING**

**FAILURE TO FOLLOW INSTRUCTIONS AND WARNINGS COULD RESULT IN SERIOUS INJURY OR DEATH.**

**WARNING** - To reduce the risk of injury to persons:

- Read and understand all the instructions, view the instructional video, review all other accompanying documents, and inspect the equipment before using the inversion table. It is your responsibility to familiarize yourself with the proper use of this equipment and the inherent risks of inversion, such as falling on your head or neck, pinching, entrapment, or equipment failure. It is the responsibility of the owner to ensure that all users of the product are fully informed about the proper use of the equipment and all safety precautions.
- Close supervision is necessary when the inversion table is used near children, or by or near invalids or disabled persons.
- Use the inversion table only for its intended use as described in this manual. **DO NOT** use attachments not recommended by the manufacturer.
- **NEVER** drop or insert any object into any opening.
- **DO NOT** use or store product outdoors.
- **DO NOT** use if you are over 6 ft 6 in (198 cm) or over 300 lbs. (136 kg). Structural failure could occur or head/neck may impact the floor during inversion.
- **DO NOT** allow children to use this machine.
- Keep children, bystanders, and pets away from machine while in use.
- Keep body parts, hair, loose clothing and jewelry clear of all moving parts.
- The inversion table has no user serviceable parts.
- This product is intended for home use only. **DO NOT** use in any commercial, rental or institutional setting.
- **DO NOT** operate equipment while under the influence of drugs, alcohol, or medication that may cause drowsiness or disorientation.
- **ALWAYS** inspect the equipment prior to use. Make sure all fasteners are secure.
- **ALWAYS** replace defective components immediately and/or keep the equipment out of use until repair.
- **ALWAYS** position equipment on a level surface and away from water or ledges that could lead to accidental immersion or falls.
- **ALWAYS** wear securely tied lace-up shoes with a flat sole, such as a normal tennis style shoe. **DO NOT** wear any footwear that could interfere with securing the ankle clamps, such as shoes with thick soles, boots, high-tops or any shoe that extends above the anklebone.
- **ALWAYS** make sure the equipment is properly adjusted to the correct user settings prior to each use.
- **DO NOT** use aggressive movements, or use weights, elastic bands or any other exercise or stretching device while on the inversion table.
- New users, and users who are physically or mentally compromised, will require the assistance of a partner to ensure they are able to find the correct balance setting and can return to an upright position unassisted.
- If you feel pain or become light-headed or dizzy while inverting, immediately return to the upright position for recovery and eventual dismount.
- **DO NOT** use the equipment without a licensed physician’s approval. Carefully review the following list of medical contraindications for inversion with your licensed physician: (This is not an exhaustive list, it is intended only for reference)
 

· Middle ear infection	· Glaucoma	· Heart or circulatory disorders	· Bone weakness (osteoporosis)
· Extreme obesity	· Retinal detachment	· Spinal injury	· Recent or unhealed fractures
· Pregnancy	· Conjunctivitis	· Cerebral sclerosis	· Medullary pins
· Hiatal hernia	· High blood pressure	· Acutely swollen joints	· Surgically implanted orthopedic supports
· Ventral hernia	· Hypertension	· Recent stroke or transient ischemic attack	· Use of anticoagulants (including high doses of aspirin)
- Refer to additional warning notices posted on the equipment. If a product label or Owner’s Manual should become lost, damaged or illegible, contact Customer Service for replacement.

USA: 1-800-847-0143, info@teeter-inversion.com  
International: +1-242-362-1001, info@inversioninternational.com

# MOUNTING

**BEFORE YOU INVERT** make sure that the table rotates smoothly to the fully inverted position and back, and that all fasteners are secure. Make sure the user settings described below are properly adjusted for your unique needs and body type. Take your time finding your proper settings and remember them. Check these settings every time prior to using the equipment.

## Rotation Adjustment: Find Your Setting

The Rotation Adjustment Setting controls the responsiveness or rate of rotation. There are three holes; the hole selection depends both on your body weight and the rotational responsiveness you desire (diagram at right). For users just learning to use the inversion table, we recommend starting with Setting C (Figure 1). **IMPORTANT:** Set the Rotation Adjustment Arms in the same hole setting on each side. See more detailed instructions on using the Pinlock Knob in the Assembly Instructions or refer to the instructional labels on your inversion table.

	A Top – closest to roller Most Responsive Setting	B Middle Moderately Responsive	C Bottom – furthest from roller Least Responsive	
80 - 120 lbs.	● X			(36 - 54 kg.)
120 - 220 lbs.	X	●		(54 - 100 kg.)
220 - 300 lbs.	X	X	●	(100 - 136 kg.)

● Beginner / Partial Inversion  
X Suggested for Full Inversion

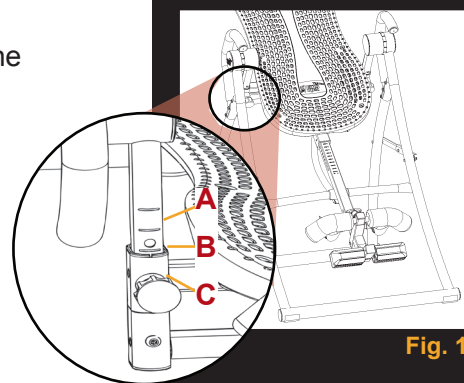

Fig. 1

## Height Setting: Adjust the Main Shaft

The height settings are labeled on the Main Shaft in both inches and centimeters.

- Loosen the De-rattler knob.
- Pull out the height selector locking pin with your right hand while sliding the Main Shaft with your left (Figure 2).
- Slide the Main Shaft until the last setting you can read is one inch greater than your height. e.g. If you're 5'10" (178 cm) the last numbers you'll be able to read will be 5'11" (180 cm). **NOTE:** The best height setting for you will depend on your weight distribution and could vary one or two inches on either side of your actual height. Starting at one or two inches more than your height will help to ensure that the rotation of the table is not too fast.
- Release the height selector locking pin so that it fully engages in a hole. If you choose, re-tighten the De-rattler knob.

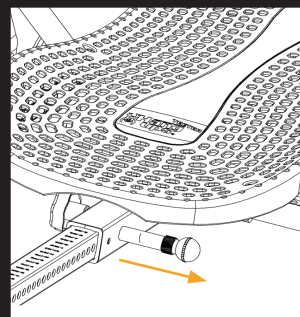

Fig. 2

## Tether Strap: Adjust to Desired Angle

For first time users, attach the Tether Strap to help control your angle of rotation (Figure 3). You can increase the angle of rotation allowed by the Tether Strap as you become more comfortable using the table, or remove it all together for full inversion.

## Ankle Comfort Dial: Find Your Setting

The Ankle Comfort Dial can rotate into a High or Low setting (Figure 4). There is a one inch height difference between the settings. The setting you select will vary by the type of shoes you wear and your ankle type. Try inverting in both settings to determine which one is most comfortable for you.

The Ankle Comfort Dial should be set so the ankle clamps are secure around the smallest part of the ankles (with minimal distance between the ankle clamp and the top of your foot); this will reduce sliding on the Table Bed while inverted.

## Prepare to Mount

- ALWAYS** wear securely tied, lace up shoes with a flat sole, such as a tennis shoe.
- DO NOT** wear shoes with thick soles, boots, high-tops or any shoe that extends above the ankle bone, as this type of footwear could interfere with properly securing your ankles.

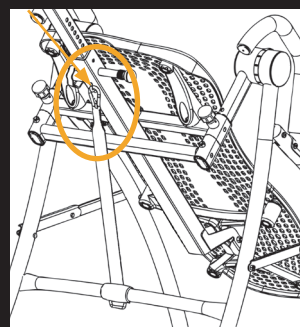

Fig. 3

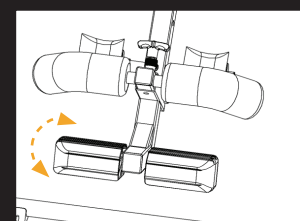

Fig. 4

## Securing Your Ankles

- Stand with your back to the Table Bed - do not use the inversion table face down.
- Step over the Main Shaft, placing your feet on the floor on either side. To balance yourself, rest only your lower body against the Table Bed as you slide one ankle at a time between the ankle clamps onto the Ankle Comfort Dial. Be sure to slide your ankle in from the side (Figure 5); **DO NOT** insert the foot through the ankle clamps as you would slide your foot into a shoe. Your feet should always be either on the floor or on the Ankle Comfort Dial; never use any other part of the inversion table as a step (Figure 6 and 7).

**WARNING**  
**DO NOT** step on the crossbar of the A-frame or on top of the ankle clamps as this could cause the table to rotate resulting in serious injury or death!

- Press your ankles back firmly against the rear ankle clamps.
- Rotate the top of the rear clamps slightly inward toward your ankles, this will increase your comfort while inverting.
- Pull the locking pin out to allow the front ankle clamps to snap closed against your ankles (Figure 8). Make sure your pant legs do not interfere with obtaining a secure closure.
- Adjust the front ankle clamps to make sure both the front and rear ankle clamps are snug against your ankles. Release the locking pin so that it fully engages a hole setting (Figure 9).
- If the locking pin does not automatically engage in a hole (Figure 10), push the front ankle clamps inward until the pin engages fully in the next tightest hole setting. Verify that no part of the footwear or garments can touch or interfere with the locking pin in any way during inversion.
- Use the concept of **HEAR - FEEL - SEE** every time you secure your ankles: **HEAR** the locking pin click into place; **FEEL** the locking pin to make sure it is fully engaged in a hole setting; **SEE** that there is **NO** space between the locking pin and its base.

**WARNING**  
**DO NOT** lean your upper body against the Table Bed before securing your ankles.  
**FAILURE** to engage the ankle locking pin fully could result in serious injury or death!  
**DO NOT** deviate from these instructions.

## Test Your Balance Setting

The inversion table is sensitively balanced and it responds to very small changes in weight distribution. As a result, you must always test to make sure you have the correct height setting. Ensure that there is clearance to rotate in front, above and behind you. To begin, rest your head on the bed and place your arms at your sides, then slowly place your arms on your chest.

- If your head is lower than your feet, lengthen the height setting by one hole and test again.
- If your feet do not move at all, shorten the height setting by one hole and test again.
- If the table comes to rest with your feet lifted a few inches off the A-frame, then you have found the correct balance setting (Figure 11).

This is an important step - spend the time needed to find your correct balance setting. Your setting should remain the same as long as your weight does not fluctuate substantially.

**WARNING**  
For your first few inversion sessions, ask a spotter to assist you until you are able to find your correct balance setting and are comfortable with the operation of the table.

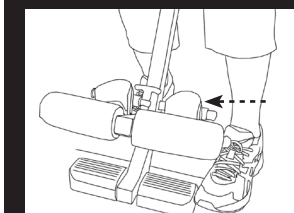

Fig. 5



Fig. 6



Fig. 7

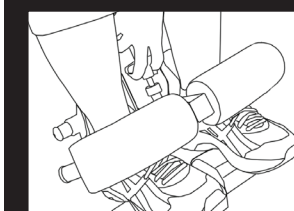

Fig. 8

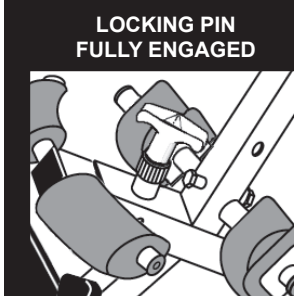

Fig. 9

**DANGER: LOCKING PIN NOT ENGAGED**

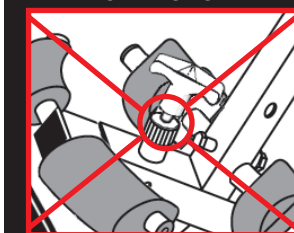

Fig. 10

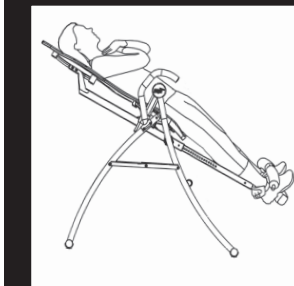

Fig. 11